

PRODUCT CATALOG

2024

PITCHED ROOF

NXT UMount | OPEN CHANNEL RAIL-BASED MOUNTING SYSTEM

ALL System Components 1

SOLARMOUNT | RAIL-BASED MOUNTING SYSTEM

SOLARMOUNT Rail 3

Rail Clamps – UNIVERSAL AF, PRO SERIES & Standard SM 4

Roof Attachments – SM BUTYL, FLASHLOC, and FLASHKIT PRO 5

Roof Attachments - FLASHKIT Tile Replacement, and SOLARHOOKS 6

Roof Attachments – 2-Piece Al Standoffs, Metal Roof Attachments, and SM Adjustable Tilt Legs 7

Grounding & Wire Management, Optional Trim & Rail Caps 8

Spare Hardware 9

SFM INFINITY | RAIL-LESS MOUNTING SYSTEM

Micro rail & Splices, Trim Components, COMP Shingle Roof Attachments 10

TILE Roof Attachments, Wire Management, MLPE Mounts and Hex Tool 11

METAL X | METAL ROOF RAIL-LESS MOUNTING SYSTEM

Clamps, Couplings, Hardware 12

Metal Roof Attachments, MLPE Mounts, Wire Management Clips 13

Screw, and Row-to-Row Bonding 14

FLAT ROOF

RM10 EVO | SOUTH FACING 10 DEGREE TILT MOUNTING SYSTEM

ALL System Components 15

GRIDFLEX™ | BUILT FOR SPEED FLAT ROOF SYSTEM

ALL System Components 16

GRIDFLEX 10™ | BUILT FOR SPEED FLAT ROOF SYSTEM

ALL System Components 17

RM5 | SOUTH FACING 5 DEGREE TILT MOUNTING SYSTEM

ALL System Components 18

RMDT | 8 DEGREE EAST-WEST TILT MOUNTING SYSTEM

ALL System Components 19

ECOFOOT2+ | UNIVERSAL BALLASTED MOUNTING SYSTEM

ALL System Components 20

ECOFOOT5D | HIGH DENSITY 5 DEGREE MOUNTING SYSTEM

ALL System Components 21

TABLE OF CONTENTS



GROUND MOUNT

GROUND FIXED TILT (GFT) | GROUND MOUNT SYSTEM

ALL System Components 23

UNIRAC LARGE ARRAY | GROUND MOUNT SYSTEM

ALL System Components 24

E-BOSS / ACCESSORIES

SOLOBOX, Critter Guard, Conduit Mount, MLPE, Ground Lug, Wire Management Clip 25

NXT UMOUNT RAIL & SPLICE

P/N	DESCRIPTION	PACK SIZE	SHIP WT. LBS
185RLD1	NXT UMOUNT RAIL - 185" DARK	168	1000
185RLM1	NXT UMOUNT RAIL - 185" MILL	168	1000
168RLD1	NXT UMOUNT RAIL - 168" DARK	168	1000
168RLM1	NXT UMOUNT RAIL - 168" MILL	168	1000
096RLD1	NXT UMOUNT RAIL - 96" DARK	168	520
096RLM1	NXT UMOUNT RAIL - 96" MILL	168	520
084RLD1	NXT UMOUNT RAIL - 84" DARK	168	460
084RLM1	NXT UMOUNT RAIL - 84" MILL	168	460
RLSPLCM2	NXT UMOUNT RAIL SPLICE	20	2



NXT UMOUNT® RAIL SYSTEM

NXT UMOUNT MODULE CLAMPS

P/N	DESCRIPTION	PACK SIZE	SHIP WT. LBS
CCLAMPD1	NXT UMOUNT COMBO CLAMP - DARK	20	37
CCLAMPM1	NXT UMOUNT COMBO CLAMP - MILL	20	37
NUHECLMP1	NXT HIDDEN END CLAMP W/ CAP	4	

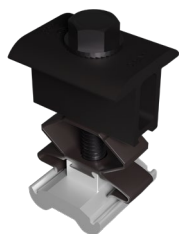

NXT UMOUNT® COMBO CLAMP

STRONGHOLD ATTACHMENTS

P/N	DESCRIPTION	PACK SIZE	SHIP WT. LBS
SHBUTYLD2	STRONGHOLD BUTYL ATT KIT #14S DARK	20	11.5
SHBUTYLM2	STRONGHOLD BUTYL ATT KIT #14S MILL	20	11.5
SHCLMPD2	STRONGHOLD RAIL CLAMP DARK	20	4
SHCLMPM2	STRONGHOLD RAIL CLAMP MILL	20	4
SHCPKT1	STRONGHOLD ATT KIT COMP DRK	20	13
SHCPKM1	STRONGHOLD ATT KIT COMP MILL	20	13
XTRABUTL-SH	EXTRA BUTYL PAD - SH, KIT	30	
NUMTLCLMPD	NXT METAL ROOF RAIL CLAMP DARK	20	4
NUMTLCLMPM	NXT METAL ROOF RAIL CLAMP MILL	20	4



STRONGHOLD™ ATTACHMENT KIT

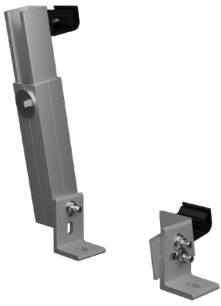

NXT UMOUNT® ADJUSTABLE TILT LEGS

NXT ADJUSTABLE TILT LEGS & L-FEET

P/N	DESCRIPTION	PACK SIZE	SHIP WT. LBS
NUTILTLEG12	NXT ADJ TILT KIT, 12", W/HDW	10	
NUTILTLEG30	NXT ADJ TILT KIT, 30", W/HDW	10	



NXT UMOUNT® MLPE & LUG CLAMP

WIRE MANAGEMENT & ACCESSORIES

P/N	DESCRIPTION	PACK SIZE	SHIP WT. LBS
ENDCAPD1	NXT UMOUNT RL & CLMP CAP KIT	20	5
WRMCLPD1	NXT UMOUNT WIRE MGMT CLIP	20	1
WRMCNSD1	NXT UMOUNT NS WIRE MGMT CLIP	20	13
NULGMLP1	NXT MLPE & GND LUG CLAMP	20	20

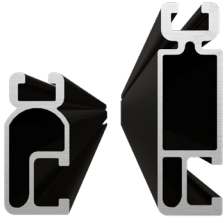

SOLARMOUNT® RAIL SYSTEM

SOLARMOUNT LIGHT RAILS-DISTRIBUTOR PACK

P/N	DESCRIPTION	PACK SIZE	SHIP WT. LBS
315185D	SM LIGHT RAIL 185" DRK	144	1512
315185M	SM LIGHT RAIL 185" MILL	144	1512
315246D	SM LIGHT RAIL 246" DRK	144	1452.38
315246M	SM LIGHT RAIL 246" MILL	144	1452.384

SOLARMOUNT STANDARD RAILS-DISTRIBUTOR PACK

P/N	DESCRIPTION	PACK SIZE	SHIP WT. LBS
310132C	SM RAIL 132" CLR	144	1188
320132M	SM RAIL 132" MILL	144	1188
310168C	SM RAIL 168" CLR	144	1512
320168M	SM RAIL 168" MILL	144	1512
310168D	SM RAIL 168" DRK	144	1512
320185M	SM RAIL 185" MILL	144	1665
310185D	SM RAIL 185" DRK	144	1665
310246C	SM RAIL 246" CLR	144	2214
320246M	SM RAIL 246" MILL	144	2214
310246D	SM RAIL 246" DRK	144	2214

SOLARMOUNT STANDARD RAILS-PRO-PAK BUNDLE OF 8 RAILS

P/N	DESCRIPTION	PACK SIZE	SHIP WT. LBS
310246C-B	SM RAIL 246" CLR 8PK	8	123
320246M-B	SM RAIL 246" MILL 8 PK	8	123



UNIVERSAL AF END CLAMPS

UNIVERSAL AESTHETIC FASTENER (AF) MODULE CLAMPS

P/N	DESCRIPTION	PACK SIZE	SHIP WT. LBS
302045D	UNIVERSAL AF MID CLAMP DRK	20	2.2
302045M	UNIVERSAL AF MID CLAMP MILL	20	2.2
302050D	UNIVERSAL AF END CLAMP DRK	20	2.95
302050M	UNIVERSAL AF END CLAMP MILL	20	2.95

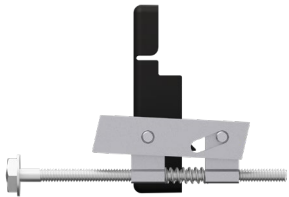

PRO SERIES HIDDEN END CLAMP

PRO SERIES MODULE CLAMPS

P/N	DESCRIPTION	PACK SIZE	SHIP WT. LBS
302030D	SM MIDCLAMP PRO DRK	20	2.2
302030M	SM MIDCLAMP PRO MILL	20	2.2
302035M	SM ENDCLAMP PRO W/CAP	4	0.6

SOLARMOUNT STANDARD MODULE CLAMPS

P/N	DESCRIPTION	PACK SIZE	SHIP WT. LBS
302021C	SM ENDCLAMP B CLR AL	20	2
302021D	SM ENDCLAMP B DRK AL	20	2
302022C	SM ENDCLAMP C CLR AL	20	2
302022D	SM ENDCLAMP C DRK AL	20	2
302023C	SM ENDCLAMP D CLR AL	20	2
302023D	SM ENDCLAMP D DRK AL	20	2
302024C	SM ENDCLAMP E CLR AL	20	2
302024D	SM ENDCLAMP E DRK AL	20	2
302025C	SM ENDCLAMP F CLR AL	20	2
302025D	SM ENDCLAMP F DRK AL	20	2
302026C	SM ENDCLAMP K CLR AL	20	2
302026D	SM ENDCLAMP K DRK AL	20	2
302027C	SM BND MIDCLAMP BC SS	20	2
302027D	SM BND MIDCLAMP BC DRK SS	20	2
302028C	SM BND MIDCLAMP EF SS	20	2
302028D	SM BND MIDCLAMP EF DRK SS	20	2
302029C	SM BND MIDCLAMP DK SS	20	2
302029D	SM BND MIDCLAMP DK DRK SS	20	2



SOLARMOUNT® ENDCLAMP



SOLARMOUNT® MID CLAMP



SOLARMOUNT® BUTYL

SOLARMOUNT BUTYL ATTACHMENTS

P/N	DESCRIPTION	PACK SIZE	SHIP WT. LBS
003251W	DTD #14 3IN SELF-DRILL SCREW	80	
004BUTYLD	SOLARMOUNT BUTYL ATT KIT #14S	20	
004BUTYLM	SOLARMOUNT BUTYL ATT KIT #14S	20	
XTRABUTL-SH	EXTRA BUTYL PAD - SH, KIT	30	



FLASHLOC™ DUO

FLASHLOC ATTACHMENTS

P/N	DESCRIPTION	PACK SIZE	SHIP WT. LBS
003250W	#12-14 X 2.50 SCREW HDW SS SD	80	
004275D	FLASHLOC DUO DARK	20	10
004085D	FLASHLOC COMP KIT DRK	20	10
004085M	FLASHLOC COMP KIT MILL	20	10

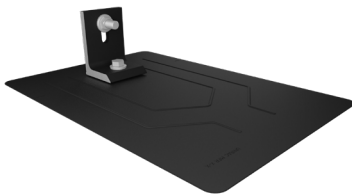

FLASHKIT PRO

FLASHKIT PRO & SWITCHBLADE (SB) ATTACHMENTS

P/N	DESCRIPTION	PACK SIZE	SHIP WT. LBS
004015D	FLASHKIT SB, DARK	10	5.5
004015M	FLASHKIT SB, MILL	10	5.5
004055D	FLASHKIT PRO, DRK 10PK	10	7.35
004055M	FLASHKIT PRO, MILL 10PK	10	7.35



SOLARMOUNT® RAIL SPLICE

SOLARMOUNT RAIL SPLICE

P/N	DESCRIPTION	PACK SIZE	SHIP WT. LBS
303019D	BND SPLICE BAR PRO SERIES DRK	20	9
303019M	BND SPLICE BAR PRO SERIES MILL	20	9

FLASHKIT TILE REPLACEMENT TILE ROOF ATTACHMENTS

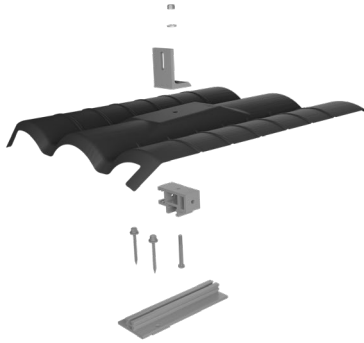

FLASHKIT TR W-TILE

P/N	DESCRIPTION	PACK SIZE	SHIP WT. LBS
004TRFA	FLASHKIT TR FLAT-TILE ADOBE	10	30
004TRFD	FLASHKIT TR FLAT-TILE CHARCOAL	10	30
004TRFM	FLASHKIT TR FLAT-TILE MILL	10	30
004TRSA	FLASHKIT TR SPAN-TILE ADOBE	10	31
004TRSD	FLASHKIT TR SPAN-TILE CHARCOAL	10	31
004TRSF	TR UNIV SUB-FLASHING	50	10
004TRSM	FLASHKIT TR SPAN-TILE MILL	10	31
004TRWA	FLASHKIT TR W-TILE ADOBE	10	31
004TRWD	FLASHKIT TR W-TILE CHARCOAL	10	31
004TRWM	FLASHKIT TR W-TILE MILL	10	31



SOLARHOOK UNIVERSAL

SOLARHOOK TILE ROOF ATTACHMENTS

P/N	DESCRIPTION	PACK SIZE	SHIP WT. LBS
004AST1	SOLARHOOK ADJ STONE COATED ST1	30	32
004AT1H	SOLARHOOK FLAT TILE	30	32
004CT1H	SOLARHOOK SPANISH 7" BASE	20	26
004CT2H	SOLARHOOK SPANISH 9" BASE	20	30
004CT5H	SOLARHOOK UNIVERSAL	30	46
004FLAT	SOLARHOOK FLASHING FLAT	30	16.5
004FLCT	SOLARHOOK FLASHING SPANISH FLCT	30	16.5
004ST1S	SOLARHOOK STONE COATED MT ST1	30	55
035014C	HDW LAG BOLT, 1/4 X 3-1/2 SS	60	2.5

SOLARHOOK TILE FLASHINGS

P/N	DESCRIPTION	PACK SIZE	SHIP WT. LBS
004TFFM	TILE FLASHING FLAT MILL	30	
004TFSM	TILE FLASHING SPANISH MILL	30	
004TFWM	TILE FLASHING W MILL	30	

TWO-PIECE ALUMINUM STANDOFF ROOF ATTACHMENT

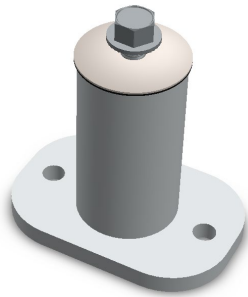

ALUMINUM STANDOFF

P/N	DESCRIPTION	PACK SIZE	SHIP WT. LBS
004013C	FLASH SOFT AL 18X18 OATEY12836	12	11
004300D	STANDOFF 3" 2 PIECE AL, DRK	24	15
004300M	STANDOFF 3" 2 PIECE AL, MILL	24	15
004400D	STANDOFF 4" 2 PIECE AL, DRK	24	17
004400M	STANDOFF 4" 2 PIECE AL, MILL	24	17
004600D	STANDOFF 6" 2 PIECE AL, DRK	24	21
004600M	STANDOFF 6" 2 PIECE AL, MILL	24	21
004700D	STANDOFF 7" 2 PIECE AL, DRK	24	22
004700M	STANDOFF 7" 2 PIECE AL, MILL	24	23
330007M	3/8 BOLT/WASHER TO AL STANDOFF	24	1



STANDING SEAM

METAL ROOF ATTACHMENTS

P/N	DESCRIPTION	PACK SIZE	SHIP WT. LBS
004130M	STANDING SEAM CLAMP, MINI 1SS	50	25.2
004131M	STANDING SEAM CLAMP, STAND 2SS	50	27.8
004132M	STANDING SEAM CLAMP, WIDE 2SS	50	30.3
004257M	R-PANEL METAL ROOF MNT, 9000-S	50	24.1
004259M	R-PANEL POWERMOUNT ADJUST	50	

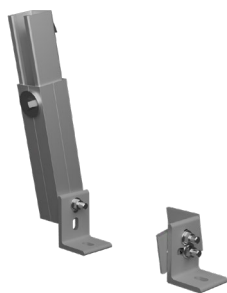

SOLARMOUNT TILT LEG

SOLARMOUNT ADJUSTABLE TILT LEGS & L-FEET

P/N	DESCRIPTION	PACK SIZE	SHIP WT. LBS
304001C	L-FOOT SERRATED W/ T-BOLT, CLR	20	5
304001D	L-FOOT SERRATED W/ T-BOLT, DRK	20	5
307120M	SM ADJ TILT LEG, 44", W/HDW	1	4
307134M	SM ADJ TILT LEG, 72", W/HDW	1	5
SMTILTLEG12	SM ADJ TILT KIT, 12", W/HDW	10	
SMTILTLEG30	SM ADJ TILT KIT, 30", W/HDW	10	

GROUNDING, BONDING, WIRE MANAGEMENT

SOLARMOUNT INTEGRATED BONDING MLPE MOUNT

P/N	DESCRIPTION	PACK SIZE	SHIP WT. LBS
008013S	MICRO MNT BND TBOLT 1/4X3/4 SS	100	2

SOLARMOUNT WIRE MANAGEMENT CLIPS

P/N	DESCRIPTION	PACK SIZE	SHIP WT. LBS
008003S	ONE WIRE CLIP, SS, DCS 1306	500	3
008004S	TWO WIRE CLIP, SS, DCS 1307	500	3
008017S	HEYCO SUNRUNNER 2-S CLIP 100/B	500	7
008018S	HEYCO SUNRUNNER 4-2U CLIP 100/B	500	6
008019S	HEYCO SUNRUNNER CLIP 100/B	100	7
008020S	HEYCO SUNRUNNER 4 CLIP 100/B	100	7



HEYCO SUNRUNNER 4-2U CLIP



ILSCO LAY IN LUG

SOLARMOUNT GROUNDING & BONDING HARDWARE

P/N	DESCRIPTION	PACK SIZE	SHIP WT. LBS
008002S	GROUND WEEBLUG #1	20	2
008009P	ILSCO LAY IN LUG	20	2
008015S	WIRE BND CLIP	10	1

OPTIONAL FRONT TRIM & RAIL END CAP

SOLARMOUNT TRIM

P/N	DESCRIPTION	PACK SIZE	SHIP WT. LBS
008025S	SM TRIM END CLIP	10	0.1
206072D-B	SM TRIM 168" DRK 8PK	8	75.28



SM TRIM

SOLARMOUNT RAIL END CAP

P/N	DESCRIPTION	PACK SIZE	SHIP WT. LBS
309003P	SM RAIL END CAP, PRO UV-BLK	100	1

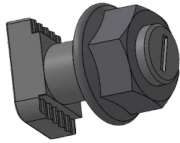

BND T-BOLT

SOLARMOUNT SPARE HARDWARE

P/N	DESCRIPTION	PACK SIZE	SHIP WT. LBS
009020S	BND T-BOLT&NUT 3/8" X 3/4" SS	20	2
009021S	BND T-BOLT&NUT 3/8" X 1" SS	20	1
030027C	HDW LAG BOLT, 5/16 X 4	50	4
030028C	HDW LAG BOLT, 5/16 X 4.5	50	4
330050D	BND T-BOLT&NUT 1/4"X2" DRK SS	20	1
330050S	BND T-BOLT&NUT 1/4"X2" SS	20	1
330051D	BND T-BOLT&NUT 1/4"X2.25"DRKSS	20	1
330051S	BND T-BOLT&NUT 1/4"X2.25" SS	20	1
330052D	BND T-BOLT&NUT 1/4"X2.5" DRKSS	20	1
330052S	BND T-BOLT&NUT 1/4"X2.5" SS	20	1



SFM INFINITY® RAIL-LESS SYSTEM

SFM INFINITY MICRORAILS & SPLICES

P/N	DESCRIPTION	PACK SIZE	SHIP WT. LBS
008000U	SFM N/S BONDING CLAMP	20	3
250010U	SFM SPLICE 6.5"	10	10
250020U	SFM MICRORAIL 2"	10	6.25
250030U	SFM ATTACHED SPLICE 8"	10	15
253010U	SFM SPLICE 6.5" 30MM	10	10
253020U	SFM MICRORAIL 2" 30MM	10	6.25
253030U	SFM ATTACHED SPLICE 8" 30MM	10	15

SFM INFINITY STRUCTURAL TRIM COMPONENTS

P/N	DESCRIPTION	PACK SIZE	SHIP WT. LBS
008100U	SFM TRIM BONDING CLAMP	10	1
009040S	SFM TRINUT KIT	100	8
250111U	SFM TRIMRAIL UNIV CLIP W/HDW	10	3
250120U	SFM TRIM SPLICE DRK	10	8
250130U	SFM TRIM END CAPS	10	0.5
256072U	SFM TRIMRAIL 72" UNIV DRK	4	22.46

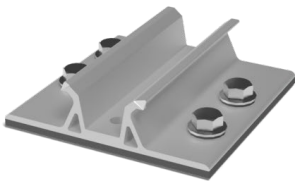

SFM BUTYL

SFM INFINITY BUTYL ATTACHMENT

P/N	DESCRIPTION	PACK SIZE	SHIP WT. LBS
SFMBTLM1	SFM BUTYL ATT KIT #14S MILL	20	

SFM INFINITY FLASHKIT PRO COMP SHINGLE ROOF ATTACHMENTS

P/N	DESCRIPTION	PACK SIZE	SHIP WT. LBS
004080D	FLASHKIT SFM NRE COMP DARK	5	8
004200D	FLASHKIT SFM TRIM COMP DARK	10	10
004201D	FLASHKIT SFM TRIM S COMP DARK	10	7
004270D	FLASHKIT SFM SLIDER COMP DARK	10	9
004271D	FLASHKIT SFM SLIDER S COMP DARK	10	7
030040C	STRUCTURAL SCREW 5/16 X 4 SS	50	3.5
030045C	STRUCTURAL SCREW 5/16 X 4.5 SS	50	3

SFM INFINITY TILE ROOF ATTACHMENTS

P/N	DESCRIPTION	PACK SIZE	SHIP WT. LBS
00520TR	FLASHKIT SFMTR TRIM ATT (2/2)	10	8
00527TR	FLASHKIT SFMTR SLIDER (2/2)	10	7
005TRFA	FLASHKIT SFMTR F ADOBE (1/2)	10	26
005TRFD	FLASHKIT SFMTR F CHARCL (1/2)	10	26
005TRFM	FLASHKIT SFMTR F MILL (1/2)	10	26
005TRSA	FLASHKIT SFMTR S ADOBE (1/2)	10	27
005TRSD	FLASHKIT SFMTR S CHARCL (1/2)	10	27
005TRSM	FLASHKIT SFMTR S MILL (1/2)	10	27
005TRWA	FLASHKIT SFMTR W ADOBE (1/2)	10	26
005TRWD	FLASHKIT SFMTR W CHARCL (1/2)	10	26
005TRWM	FLASHKIT SFMTR W MILL (1/2)	10	26

SFM INFINITY WIRE MANAGEMENT CLIPS

P/N	DESCRIPTION	PACK SIZE	SHIP WT. LBS
008003S	ONE WIRE CLIP, SS, DCS 1306	500	3
008004S	TWO WIRE CLIP, SS, DCS 1307	500	3
008017S	HEYCO SUNRUNNER 2-S CLIP 100/B	500	7
008018S	HEYCO SUNRUNNER 4-2U CLIP 100/B	500	6
008019S	HEYCO SUNRUNNER CLIP 100/B	100	7
008020S	HEYCO SUNRUNNER 4 CLIP 100/B	100	7
205000S	ENPHASE ENGAGE CABLE CLIP	100	4



HEYCO SUNRUNNER 4-2U CLIP

SFM INFINITY MLPE MOUNT

P/N	DESCRIPTION	PACK SIZE	SHIP WT. LBS
008114M	MLPE MOUNT ASSY	10	1

SFM INFINITY HEX TOOL

P/N	DESCRIPTION	PACK SIZE	SHIP WT. LBS
009030S	UNIRAC 1/4" HEX TOOL	10	1

METALX CLAMPS & COUPLINGS

P/N	DESCRIPTION	PACK SIZE	SHIP WT. LBS
ES10146	METALX END COUPLING	24	16
ES10368	METALX COUPLING	24	28
ES10828	METALX END CLAMP	108	24
ES10829	METALX MID CLAMP	108	31
ES10835	METALX END 30 CLAMP	108	23
ES10836	METALX MID 30 CLAMP	108	30
ES10924	METALX COUPLING 30MM	24	

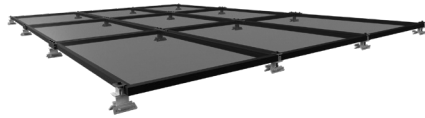

METAL X® RAIL-LESS SYSTEM

METALX CLAMP HARDWARE

P/N	DESCRIPTION	PACK SIZE	SHIP WT. LBS
ES10079	BOLT, SERR FLNG BLK, 5/16X2.5	100	
ES10085	BOLT, SERR FLNG BLK, 5/16X2	100	
ES10271	BOLT, SERR FLNG BLK, 5/16X3	100	5
ES10325	5/16-18 SERR FLNG HEX NUT	100	2
ES10889	BOLT, CAP HEX, M8 X 55	200	12
ES10890	BOLT, CAP HEX, M8 X 60	200	12
ES10891	BOLT, CAP HEX, M8 X 65	200	12
ES10892	BOLT, CAP HEX, M8 X 70	200	12
ES10893	BOLT, CAP HEX, M8 X 75	200	12
ES10894	WASHER, M8	200	2



STANDING SEAM CLAMP

METAL ROOF ATTACHMENTS

P/N	DESCRIPTION	PACK SIZE	SHIP WT. LBS
004130M	STANDING SEAM CLAMP, MINI 1SS	50	25.2
004131M	STANDING SEAM CLAMP, STAND 2S!	50	27.8
004132M	STANDING SEAM CLAMP, WIDE 2SS	50	30.3
004257M	R-PANEL METAL ROOF MNT, 9000-S	50	24.1
004259M	R-PANEL POWERMOUNT ADJUST	50	
ES10674	STANDING SEAM, STAND 2SS 5/16"	50	24
ES10675	STANDING SEAM, KLOC 2SS 5/16"	48	26
ES10676	STANDING SEAM, WIDE 2SS 5/16"	48	30
ES10830	CORRUBRACKET 100T	60	35
ES10875	RIBBRACKET I	75	36
ES10877	RIBBRACKET II	75	36
ES10879	RIBBRACKET III	75	36
ES10881	RIBBRACKET IV	75	36
ES10918	STANDING SEAM, MINI 2SS 5/16"	48	24
ES10919	STANDING SEAM, KLOC MINI 5/16"	48	24
ES11209	PM ADJUST SLOTTED	50	23

METAL X MLPE MOUNT & WIRE MANAGEMENT CLIPS

P/N	DESCRIPTION	PACK SIZE	SHIP WT. LBS
008003S	ONE WIRE CLIP, SS, DCS 1306	500	3
008004S	TWO WIRE CLIP, SS, DCS 1307	500	3
008017S	HEYCO SUNRUNNER 2-S CLIP 100/B	500	7
008018S	HEYCO SUNRUNNER 4-2U CLIP 100/B	500	6
008019S	HEYCO SUNRUNNER CLIP 100/B	100	7
008020S	HEYCO SUNRUNNER 4 CLIP 100/B	100	7
205000S	ENPHASE ENGAGE CABLE CLIP	100	4
008021S	SINGLE TRUNK CABLE CLIP	100	7
008115M	MLPE TIGER CLIP	48	11

METAL ROOF SCREWS

P/N	DESCRIPTION	PACK SIZE	SHIP WT. LBS
ES10831	ROOFING SCREW, METAL TO WOOD, 1.5"	240	12
ES10883	ROOFING SCREW, METAL TO METAL, 1.5"	240	12

METALX ROW-TO-ROW BONDING

P/N	DESCRIPTION	PACK SIZE	SHIP WT. LBS
ES10201	ECOX BONDING JUMPER 8"	5	1
ES10260	ECOX ROW TO ROW BONDING CLIP	800	4
ES11108	METALX 30MM ROW BONDING CLIP	10	0.1

RM10 EVO BALLAST BAYS, CLAMPS & MID SUPPORT



RM10 EVO FLAT ROOF SYSTEM

P/N	DESCRIPTION	PACK SIZE	SHIP WT. LBS
370010	RM10 EVO FIELD BAY	50	
370011	RM10 EVO NORTH BAY	72	
370022	EVO MOD CLAMP SIDE BOLT BULK	100	
370023	EVO MOD CLAMP BULK	100	
370030	EVO MID SUPPORT	20	355
370010-US	RM10 EVO FIELD BAY (US)	50	

RM10 EVO MLPE MOUNTS, GROUNDING & BONDING HARDWARE

P/N	DESCRIPTION	PACK SIZE	SHIP WT. LBS
008114M	MLPE MOUNT ASSY	10	1
008115M	MLPE TIGER CLIP	48	11
205000S	ENPHASE ENGAGE CABLE CLIP	100	4
008002S	GROUND WEEBLUG #1	20	2
008009P	ILSCO LAY IN LUG	20	2

RM10 EVO ROOF PAD & ATTACHMENT KIT

P/N	DESCRIPTION	PACK SIZE	SHIP WT. LBS
310760	RM10 EVO ROOF PAD	200	35
310771	RM10 EVO ATTACHMENT KIT	1	2.5

FLASHLOC RM FLAT ROOF ATTACHMENT

FLASHLOC™ RM is a lightweight, durable, powder-coated cast aluminum roof attachment solution that provides fast, easy installation and helps save labor costs. FLASHLOC™ RM is compatible with most roofing materials and is applicable for almost all solar racking form factors. Rigorous mechanical, sealing, and ease-of-install testing has been successfully completed for assurance of long-term reliability.



FLASHLOC RM

P/N	DESCRIPTION	PACK SIZE	SHIP WT. LBS
310999	FLASHLOC RM	10	17

GRIDFLEX COMPONENTS

P/N	DESCRIPTION	PACK SIZE	SHIP WT. LBS
360010	GRIDFLEX NORTH RAIL	20	23
360020	GRIDFLEX MID RAIL	10	29
360030	GRIDFLEX SOUTH RAIL	20	26
360050	GRIDFLEX 5D SOUTH CLMP ASSY	20	17
360060	GRIDFLEX LANDER PAD	50	18
360061	GRIDFLEX HARDWARE KIT	80	5
360071	GRIDFLEX BALLAST TRAY, 62-69"	5	32
360081	GRIDFLEX BALLAST TRAY, 77-83"	5	36
360090	RM GRIDFLEX DEFLECTOR 62-69"	5	23
360100	RM GRIDFLEX DEFLECTOR 77-83"	5	28
360101	GRIDFLEX BALLAST TRAY, 83-92"	5	35
360102	RM GRIDFLEX DEFLECTOR, 83-92"	5	20
360110	GRIDFLEX DEFLECTOR 92-100"	5	
360120	GRIDFLEX BALLAST TRAY 92-100"	5	
360200	GRIDFLEX 5D MID SUPPORT	25	



GRIDFLEX 5 FLAT ROOF SYSTEM

GRIDFLEX 10 COMPONENTS



GRIDFLEX10 FLAT ROOF SYSTEM

P/N	DESCRIPTION	PACK SIZE	SHIP WT. LBS
360250	GRIDFLEX ATT CONNECTION KIT		
360255	GRIDFLEX ATTACHMENT ALT HDW KIT	50	
380010	GF10 SR, MW 39-45"	20	
380020	GF10 SR, MW 45-52"	20	
380100	GRIDFLEX10 MID-RAIL, MW 39-45", ROW SPACING 10/13"	20	
380110	GRIDFLEX10 MID-RAIL, MW 45-52", ROW SPACING 10/13"	20	
380120	GRIDFLEX10 MID-RAIL, MW 39-45", ROW SPACING 17"	20	
380130	GRIDFLEX10 MID-RAIL, MW 45-52", ROW SPACING 17"	20	
380200	GF10 NR	20	
380300	GRIDFLEX10 BALLAST RAIL	10	
380400	GF10 WIND DEFLECTOR <69"	10	
380401	GF10 WIND DEFLECTOR 69-73"	10	
380402	GF10 WIND DEFLECTOR 73-77"	10	
380405	GF10 WIND DEF END BRACKET	50	
380410	GF10 WIND DEFLECTOR 77-82"	10	
380420	GF10 WIND DEFLECTOR 82-87"	10	
380430	GF10 WIND DEFLECTOR 87-92"	10	
380440	GF10 WIND DEFLECTOR 92-97"	10	
380450	GF10 WIND DEFLECTOR 97-100"	10	
380600	GRIDFLEX10 NORTH CLMP ASSY	20	
380601	GRIDFLEX10 NORTH CLMP ASSY (UPDATED)	20	
380700	GF10 SOUTH CLMP ASSY	20	
380800	ROOF PAD GRIDFLEX 10	150	
380805	ROOF PAD - SNAP	50	
380900	GF10 WIRE MANAGEMENT CLIP	30	
380920	GF10 WIRE MANAGEMENT H/R	5	
380930	GRIDFLEX10 HARDWARE KIT	100	
380940	GF10 WIRE MANAGEMENT H/R, 17"	5	

RM5 BALLAST BAYS, WIND DEFLECTORS & CLAMP



RM5 FLAT ROOF SYSTEM

P/N	DESCRIPTION	PACK SIZE	SHIP WT. LBS
310800	RM5 BAY	200	1435
310803	RM5 BAY, PVC	200	1435
310810	RM5 WIND DEFLECTOR, 84"	60	385
310811	RM5 WIND DEFLECTOR, 98"	60	460
310820	RM5/DT ENDCLAMP 30-40MM	20	5.5
310821	RM5/DT ENDCLAMP 41-45MM	20	5.5
310822	RM5/DT ENDCLAMP 46-50MM	20	5.5
310861	RM5 WIND DEFLECTOR HDW KIT	20	1

RM5 ROOF FRICTION PATCH, ATTACHMENT & MID SUPPORT KIT

P/N	DESCRIPTION	PACK SIZE	SHIP WT. LBS
310830	RM5/DT PVC ROOF FRICTION PATCH	500	10
310882	RM5/DT H-ATTACHMENT KIT	1	6
310835	RM5 MID SUPPORT KIT	20	1.002

RM5 WIRE MANAGEMENT CLIPS

P/N	DESCRIPTION	PACK SIZE	SHIP WT. LBS
310850	RM5/DT WIRE MGMT CLIP	20	1
310851	RM5 WD WIRE MGMT CLIP	20	1
310860	RM5/DT 1/4-20 CLIP U-NUT SS	20	1

RM5 MLPE MOUNTS, GROUNDING & BONDING HARDWARE

P/N	DESCRIPTION	PACK SIZE	SHIP WT. LBS
008114M	MLPE MOUNT ASSY	10	1
008115M	MLPE TIGER CLIP	48	11
205000S	ENPHASE ENGAGE CABLE CLIP	100	4
008002S	GROUND WEEBLUG #1	20	2
008009P	ILSCO LAY IN LUG	20	2

FLASHLOC RM FLAT ROOF ATTACHMENT

P/N	DESCRIPTION	PACK SIZE	SHIP WT. LBS
310999	FLASHLOC RM	10	17

RMDT (DUAL-TILT)

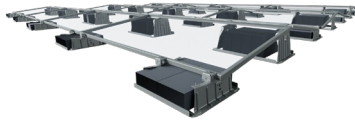

RMDT FLAT ROOF SYSTEM

RMDT BALLAST BAYS & CLAMPS

P/N	DESCRIPTION	PACK SIZE	SHIP WT. LBS
310801	RMDT RIDGE BAY	150	1575
310802	RMDT VALLEY BAY	200	1125
310804	RMDT RIDGE BAY, PVC	150	1575
310805	RMDT VALLEY BAY, PVC	200	1125
310823	RMDT MIDCLAMP 46-50MM	20	5.5
310824	RMDT MIDCLAMP 41-45MM	20	5.5
310825	RMDT MIDCLAMP 36-40MM	20	5.5
310826	RMDT MIDCLAMP 32-35MM	20	5.5

RM5 ROOF FRICTION PATCH & ATTACHMENT KIT

P/N	DESCRIPTION	PACK SIZE	SHIP WT. LBS
310830	RM5/DT PVC ROOF FRICTION PATCH	500	10
310882	RM5/DT H-ATTACHMENT KIT	1	6

RM5 WIRE MANAGEMENT CLIPS

P/N	DESCRIPTION	PACK SIZE	SHIP WT. LBS
310850	RM5/DT WIRE MGMT CLIP	20	1
310851	RM5 WD WIRE MGMT CLIP	20	1
310860	RM5/DT 1/4-20 CLIP U-NUT SS	20	1

RM5 MLPE MOUNTS, GROUNDING & BONDING HARDWARE

P/N	DESCRIPTION	PACK SIZE	SHIP WT. LBS
008114M	MLPE MOUNT ASSY	10	1
008115M	MLPE TIGER CLIP	48	11
205000S	ENPHASE ENGAGE CABLE CLIP	100	4
008002S	GROUND WEEBLUG #1	20	2
008009P	ILSCO LAY IN LUG	20	2

FLASHLOC RM FLAT ROOF ATTACHMENT

P/N	DESCRIPTION	PACK SIZE	SHIP WT. LBS
310999	FLASHLOC RM	10	17



ECOFOOT2+ FLAT ROOF SYSTEM

ECOFOOT2+ BASE, MID SUPPORT, WIND DEFLECTORS & CLAMPS

P/N	DESCRIPTION	PACK SIZE	SHIP WT. LBS
ES10466	ECOFOOT UNIVERSAL CLAMP KIT	48	51
ES11203	ECOFOOT2+ MID-SUPPORT KIT	48	33
ES20142	ECOFOOT2+ BASE W/ EPDM STRIPS	300	1285
ES20207	ECOFOOT2+ BASE	300	1226
ES20311A	ECOFOOT2+ 44" WIND DEFLECTOR	300	1525
ES20311B	ECOFOOT2+ 70" WIND DEFLECTOR	300	1776
ES20311C	ECOFOOT2+ 82" WIND DEFLECTOR	300	2014
ES20311H	ECOFOOT2+ 86" WIND DEFLECTOR	300	2094
ES20311I	ECOFOOT2+ 55" WIND DEFLECTOR	300	
ES20311K	ECOFOOT2+ 92" WIND DEFLECTOR	300	2260



ECOFOOT2+ BAY

ECOFOOT2+ WIRE MANAGEMENT, MLPE MOUNTS, ACCESSORIES & BONDING HARDWARE

P/N	DESCRIPTION	PACK SIZE	SHIP WT. LBS
ES10378	ECOFOOT BONDING JUMPER 38"	5	0.35
ES10810	ECOTRAY BASE, 6"	10	2.9
ES10811	ECOTRAY CAP 96"	10	3.9
ES10812	ECOTRAY TRAY, 96"	10	4.7
ES10813	ECOTRAY RIVET	100	4
ES10970	ECOFOOT MLPE BRACKET	48	19
ES20548	SPLICE CLEVIS 4 HOLES	10	
ES20913	ECOMOUNT 1 INVERTER KIT	1	31
ES20914	ECOMOUNT 2 INVERTER KIT	1	53

FLASHLOC RM FLAT ROOF ATTACHMENT

P/N	DESCRIPTION	PACK SIZE	SHIP WT. LBS
310999	FLASHLOC RM	10	17

ECOFOOT5D BASE, MID SUPPORT, WIND DEFLECTORS & CLAMPS



ECOFOOT5D FLAT ROOF SYSTEM

P/N	DESCRIPTION	PACK SIZE	SHIP WT. LBS
ES10466	ECOFOOT UNIVERSAL CLAMP KIT	48	51
ES10480	ECOFOOT5D MID-SUPPORT KIT	24	25
ES10486	ECOFOOT5D 71" BALLAST TRAY	250	2013
ES10488	ECOFOOT5D 83" BALLAST TRAY	250	2346
ES10490	ECOFOOT5D BASE	340	1945
ES10494	ECOFOOT5D 70" WIND DEFLECTOR	100	2027
ES10496	ECOFOOT5D 82" WIND DEFLECTOR	100	2391
ES10843	ECOFOOT ROOF TO STRUT HDWR KIT	24	17
ES10844	ECOFOOT STRUT TO MOD HDWR KIT	24	12
ES10851	ECOFOOT STRUT TO MOD KIT 30MM	24	11
ES11023	ECOFOOT5D 87" BALLAST TRAY	250	2475
ES11024	ECOFOOT5D 86" WIND DEFLECTOR	100	2515
ES11025	ECOFOOT5D 93.25" BALLAST TRAY	250	
ES11026	ECOFOOT5D 92.25" WIND DEFLECTOR	800	
ES20501	B22 GALVANIZED STRUT 10'	1	16.1

ECOFOOT5D WIRE MANAGEMENT, MLPE MOUNTS, ACCESSORIES & BONDING HARDWARE



HEYCO SUNRUNNER 4-2U CLIP

P/N	DESCRIPTION	PACK SIZE	SHIP WT. LBS
008017S	HEYCO SUNRUNNER 2-S CLIP 100/B	500	7
008018S	HEYCO SUNRUNNER 4-2U CLIP 100/	500	6
008019S	HEYCO SUNRUNNER CLIP 100/B	100	7
008020S	HEYCO SUNRUNNER 4 CLIP 100/B	100	7
008021S	SINGLE TRUNK CABLE CLIP		
ES10810	ECOTRAY BASE, 6"	10	2.9
ES10811	ECOTRAY CAP 96"	10	3.9
ES10812	ECOTRAY TRAY, 96"	10	4.7
ES10813	ECOTRAY RIVET	100	4
ES20913	ECOMOUNT 1 INVERTER KIT	1	31
ES20914	ECOMOUNT 2 INVERTER KIT	1	53
ES10378	ECOFOOT BONDING JUMPER 38"	5	0.35
ES10970	ECOFOOT MLPE BRACKET	48	19
008114M	ECOFOOT MLPE BRACKET	10	1
008115M	MLPE TIGER CLIP	48	11

FLASHLOC RM FLAT ROOF ATTACHMENT

P/N	DESCRIPTION	PACK SIZE	SHIP WT. LBS
310999	FLASHLOC RM	10	17



GROUND FIXED TILT (GFT)

GFT C-PILES

P/N	DESCRIPTION	PACK SIZE	SHIP WT. LBS
404001	GFT C-PILE, 12.5'	30	2400
404002	GFT C-PILE, 15'	30	2910
404004	GFT C-PILE, 10.5'	30	2016

GFT RAIL & SPLICE

P/N	DESCRIPTION	PACK SIZE	SHIP WT. LBS
404014	GFT RAIL SPLICE KIT	60	180
411168M	GFT RAIL 168" MILL	60	850
411246M	GFT RAIL 246" MILL	60	1200

GFT TOP CHORDS & BRACES FOR SHARED RAIL DESIGNS

P/N	DESCRIPTION	PACK SIZE	SHIP WT. LBS
404013	GFT ASSEMBLY HARDWARE 4-RAIL KIT	30	90
404031	GFT DIAGONAL BRACE ASSEMBLY 20D SR	30	630
404032	GFT DIAGONAL BRACE ASSEMBLY 30D SR	30	750
404034	GFT ASSEMBLY HARDWARE 3-RAIL KIT	30	90
404037	GFT TOP CHORD CHANNEL 20/30, LGFMT	30	

GFT WIRE MANAGEMENT CLIPS & ACCESSORIES

P/N	DESCRIPTION	PACK SIZE	SHIP WT. LBS
404015	GFT WIRE MANAGEMENT CLIP	100	5
404020	GFT RAIL SUPPLEMENTAL HDWR 4-RAIL	1	3
GFT-CAP	GFT RAIL END CAP, UV-BLK	100	3.3

UNIRAC LARGE ARRAY

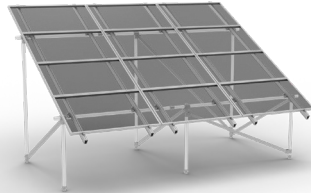

UNIRAC LARGE ARRAY

ULA COMPONENTS FOR 2-INCH SCHEDULE 40/80 PIPE

P/N	DESCRIPTION	PACK SIZE	SHIP WT. LBS
403200C	ULA BRACE, 2"@ 7 FT,	1	10
403201C	ULA BRACE, 2"@ 10.5 FT,	1	16
403202C	ULA BRACE, 2"@ 14 FT,	1	21
403211C	ULA FRONT CAP, 2", AL	1	2
403214C	ULA REAR CAP, 2", AL	1	2
403215C	ULA SLIDER, 2", AL	1	1
403216M	ULA RAIL BRACKET	1	

ULA RAILS

P/N	DESCRIPTION	PACK SIZE	SHIP WT. LBS
310132C	SM RAIL 132" CLR	144	1188
320132M	SM RAIL 132" MILL	144	1188
310168C	SM RAIL 168" CLR	144	1512
320168M	SM RAIL 168" MILL	144	1512
310168D	SM RAIL 168" DRK	144	1512
320185M	SM RAIL 185" MILL	144	1665
310185D	SM RAIL 185" DRK	144	1665
310246C	SM RAIL 246" CLR	144	2214
320246M	SM RAIL 246" MILL	144	2214
310246D	SM RAIL 246" DRK	144	2214

ULA ATTACHMENT FOR CONCRETE SLAB OR FOOTING

P/N	DESCRIPTION	PACK SIZE	SHIP WT. LBS
403216S	ULA THREADED FOOT, 2", STL	1	2



SOLOBOX RAIL

SOLOBOX JUNCTION BOX

P/N	DESCRIPTION	PACK SIZE	SHIP WT. LBS
SBOXRAIL-D	SOLOBOX RAIL W/ DIN RL	4	
SOLOBOX2-D	SOLOBOX COMP W/ DIN RAIL	8	



U-GUARD CLIP

UGARD

P/N	DESCRIPTION	PACK SIZE	SHIP WT. LBS
UGARD-M5	U-GUARD MESH 5IN	100FT	
UGARD-M6	U-GUARD MESH 6IN	100FT	
UGARD-M8	U-GUARD MESH 8IN	100FT	
UGARD-CLP	U-GUARD CLIP	20	



CONDUIT MOUNT BUTYL

E-BOSS CONDUIT MOUNTS

P/N	DESCRIPTION	PACK SIZE	SHIP WT. LBS
CMBTLM1	E-BOSS COND MT 3.0 W/ BUTL KIT	20	
00823CM	E-BOSS TILE CONDUIT MT KIT	10	
00822CM	E-BOSS CONDUIT MT 2.0 COMP KIT	10	5

MLPE MOUNTS



MLPE MOUNT

P/N	DESCRIPTION	PACK SIZE	SHIP WT. LBS
008114M	MLPE MOUNT ASSY	10	1
008115M	MLPE TIGER CLIP	48	11



ILSCO LAY IN LUG

GROUNDING & BONDING HARDWARE

P/N	DESCRIPTION	PACK SIZE	SHIP WT. LBS
008002S	GROUND WEEBLUG #1	20	2
008009P	ILSCO LAY IN LUG	20	2
008015S	WIRE BND CLIP	10	1



HEYCO SUNRUNNER 4-2U CLIP

WIRE MANAGEMENT CLIPS

P/N	DESCRIPTION	PACK SIZE	SHIP WT. LBS
008003S	ONE WIRE CLIP, SS, DCS 1306	500	3
008004S	TWO WIRE CLIP, SS, DCS 1307	500	3
008017S	HEYCO SUNRUNNER 2-S CLIP 100/B	500	7
008018S	HEYCO SUNRUNNER 4-2U CLIP 100/B	500	6
008019S	HEYCO SUNRUNNER CLIP 100/B	100	7
008020S	HEYCO SUNRUNNER 4 CLIP 100/B	100	7



SM TRIM

SOLARMOUNT TRIM

P/N	DESCRIPTION	PACK SIZE	SHIP WT. LBS
008025S	SM TRIM END CLIP	10	0.1
206072D-B	SM TRIM 168" DRK 8PK	8	75.28



RAIL TRAY

E-BOSS SOLARTRAY WIRE MANAGEMENT

P/N	DESCRIPTION	PACK SIZE	SHIP WT. LBS
00802BT	E-BOSS BRIDGE TRAY	20	11
00802RT	E-BOSS RAIL TRAY	40	18
00802BC	E-BOSS BRIDGE CLIPS	200	2

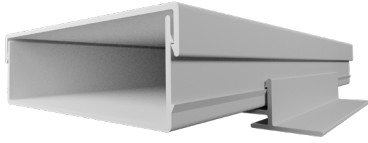

**ECOTRAY WIRE
MANAGEMENT**

EBOSS ECOTRAY

P/N	DESCRIPTION	PACK SIZE	SHIP WT. LBS
ES10810	ECOTRAY BASE, 6"	10	2.9
ES10811	ECOTRAY CAP 96"	10	3.9
ES10812	ECOTRAY TRAY, 96"	10	4.7
ES10813	ECOTRAY RIVET	100	4